

WOOD STOVES & FIREPLACE INSERTS

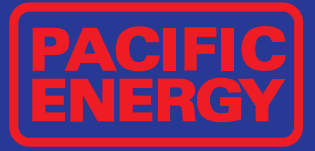

Vista Classic
Vista

Spectrum Classic
Spectrum
Super 27
Fusion

Summit
Summit Classic

Vista Insert
Pacific Insert
Summit Insert

**PACIFIC
ENERGY**



CONTENTS

Quality Time

at home begins with comfort – the feeling you get from the warmth, the sound and the fragrance of a real wood burning fireplace.

Pacific Energy wood stoves and fireplace inserts are easy to light, easy to use, economical and clean-burning. Lower your heating costs with one of the most efficient and beautiful wood stoves and inserts available today.

With three sizes of free-standing wood stoves, Pacific Energy has a solution for your heating needs. Robust heat is matched with decorating options, in both pedestal and classic legged styles and a variety of doors and industry-leading porcelain color options.

For those with an existing fireplace, choose from three sizes of fireplace inserts and striking design options to warm your home beautifully.

Wood Stoves

PRODUCT OVERVIEW	4–5
VISTA CLASSIC	6
VISTA	7
SPECTRUM CLASSIC	8
SPECTRUM	9
SUPER 27	10–11
FUSION	12–13
SUMMIT CLASSIC	14
SUMMIT	15

Wood Fireplace Inserts

PRODUCT OVERVIEW	16
VISTA INSERT	17
PACIFIC INSERT	18
SUMMIT INSERT	19

A History of Innovation

20–21

Specifications

Floor Protectors	22
Minimum Clearances	23

Porcelain Enamel

The Classic Finish	24
--------------------	----



Find The Right

SMALL

For Heating up to 1500 sq ft.

The VISTA Series

Weight: 300 lbs.

THE VISTA CLASSIC



Available in five Porcelain Enamel colours



THE VISTA (With Pedestal)



MEDIUM

For Heating up to 2000 sq ft.

The SUPER Series

Weight: 390 – 400 lbs.

THE SPECTRUM CLASSIC



Available in five Porcelain Enamel colours



THE SPECTRUM



Available in five Porcelain Enamel colours



LARGE

For Heating up to 3100 sq ft.

The SUMMIT Series

Weight: 475 lbs.

THE SUMMIT CLASSIC



Available in five Porcelain Enamel colours



THE SUMMIT (With Pedestal)



Wood Stove for You

THE VISTA
(With Legs)



DESIGN ACCENTS

All Pacific Energy Wood Stoves (except the Fusion) are customizable in your choice of door and leg finishes.



Available in Gold, Nickel, Metallic Black and Brushed Nickel

THE SUPER 27
(With Legs)



THE SUPER 27
(With Pedestal)



THE SUPER 27
(With Screen)



THE FUSION



Available in Stainless Steel
or five Porcelain Enamel colours



THE SUMMIT
(With Legs)



EXTENDED BURN TECHNOLOGY

A Summit loaded with wood will keep you warm for up to 10 hours, thanks to Extended Burn Technology (EBT). A patented innovation available only on Pacific Energy Summit Wood Stoves and Summit Inserts, EBT regulates combustion air flow, for a longer burn and more fuel economy. (See page 21 for more details.)

*US Patent #6,041,770

Burn results may vary by location, installation and wood moisture content.

The Vista Classic



STANDARD FEATURES

- User friendly, one-touch operation
- Internal "air-wash" system for super clean ceramic glass
- Reliable, durable, non-catalytic technology
- High-tech burn system
- Easy to use ash disposal system
- Inside and outside combustion air capable
- Floating firebox design
- 304 Stainless Steel insulation cover
- Mobile home approved

CHOICES

- Arched door available in Gold, Nickel, Brushed Nickel or Metallic Black
- Legs available in Gold, Nickel, Brushed Nickel or Metallic Black
- Classic Trivet available in Gold, Nickel, Brushed Nickel or Metallic Black

OPTION

- Temperature actuated 125 cfm variable speed blower



Ash disposal is clean and easy with a spring loaded removable ash drawer.

The Vista Classic – the elegant, yet powerful heating choice for spaces up to 1500 square feet. User-friendly operation and classic good looks in a range of durable and beautiful Porcelain gem tones.

PORCELAIN ENAMEL FINISH

The Vista Classic wood stoves are beautifully finished with a rich, vitreous porcelain enamel. This porcelain enamel possesses inherent qualities no other appliance finish can offer. It has the durability of steel and the scratch resistance of glass. And all five colours are guaranteed for life against fading. No special care is required to maintain its just-like-new appearance – simply wipe clean with a damp cloth.



Forest Green

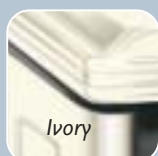

Ivory



Sunset Red

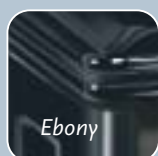

Ebony

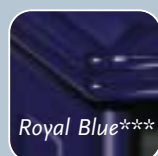

Royal Blue***

*** Available as premium colour.

Heating Capacity		1,500 sq.ft.*
HEAT OUTPUT	Cord Wood	56,000 BTU
	EPA Test Fuel	26,300 BTU
Efficiency		71.0%**
Emissions		2.9 gm/hr.
Log Size		18 inches Max.

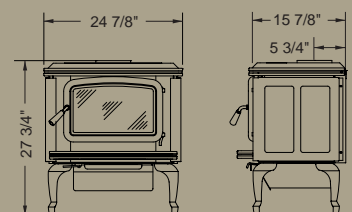

The Vista

STANDARD FEATURES

- Rich Metallic Black finish with black trim
- Heavy plate-steel top
- Steel baffle and 304 Stainless Steel insulation cover
- Reliable, durable, non-catalytic technology
- Inside and outside combustion air capable
- Mobile home approved

CHOICES

- Arched door in Gold, Nickel, Brushed Nickel or MetallicBlack
- Metallic black pedestal, or legs in four finishes: Gold, Nickel, Brushed Nickel or MetallicBlack

OPTIONS

- Ash system
- Temperature actuated 125 cfm variable speed blower



Arched doors are available in Gold, Nickel, Metallic Black or Brushed Nickel.

Traditional good looks and efficient heating in a smaller package. The Vista's craftsmanship will stand the test of time and deliver years of heating comfort in your home.

Heating Capacity		1,500 sq.ft.*
HEAT OUTPUT	Cord Wood	56,000 BTU
	EPA Test Fuel	26,300 BTU
Efficiency		71.0%**
Emissions		2.9 gm/hr.
Log Size		18 inches Max.

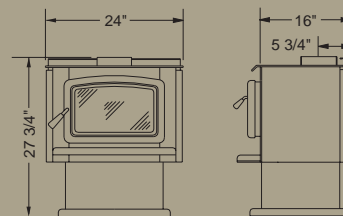

* Figures will vary depending on type of wood, floor plan, house layout, heat loss of home, and geographical location.
 **Oregon DEQ results may vary due to wood size and moisture content.

The Spectrum Classic



Pacific Energy brings you the timeless beauty of The Spectrum and The Spectrum Classic wood stoves. These high-performance wood stoves deliver real heat power with an impressive efficiency rating and user friendly operation.

PORCELAIN ENAMEL FINISH

The Spectrum wood stoves are beautifully finished with a rich, vitreous porcelain enamel. Porcelain enamel possesses inherent qualities no other appliance finish can offer. It has the durability of steel, the scratch resistance of glass, and is virtually indestructible under everyday household use. And all five colours are guaranteed for life against fading. No special care is required to maintain its just-like-new appearance – simply wipe clean with a damp cloth.

(See back cover for more about Porcelain Enamel.)



Forest Green



Ivory



Sunset Red



Ebony



Royal Blue***

*** Available as premium colour only.



Ash disposal is clean and easy with a spring loaded removable ash drawer.

The Spectrum

STANDARD FEATURES (SPECTRUM)

- Pedestal Base
- Metallic Black trivet

STANDARD FEATURES (BOTH MODELS)

- Reliable, durable non-catalytic technology
- User friendly, one-touch operation
- Straight-in fuel loading
- Long burn times
- Air wash system for super clean ceramic glass
- Boost air for easy lighting
- 304 Stainless Steel baffle, insulation cover, rails and flame shield (See page 21)
- Floating firebox design
- Easy to use ash disposal system
- Inside and outside combustion air compatible
- Mobile home approved

CHOICES

SPECTRUM CLASSIC

- Legs available in Gold, Nickel, Brushed Nickel or Metallic Black

CHOICES (BOTH MODELS)

- Two door styles, Arched or Radiant, available in Gold, Nickel, Brushed Nickel or Metallic Black (See below)
- Classic Trivet available in Gold, Nickel, Brushed Nickel or Metallic Black

OPTIONS

(BOTH MODELS)

- Temperature actuated 125 cfm variable speed blower
- Screen Door



Optional
Screen Door



Gold



Nickel



Brushed Nickel



Metallic Black

THE SPECTRUM CLASSIC

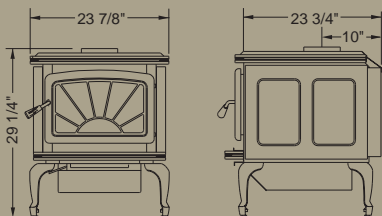

Heating Capacity		2,000 sq.ft.*
HEAT OUTPUT	Cord Wood	72,000 BTU
	EPA Test Fuel	34,600 BTU
Efficiency		69.3%**
Emissions		3.4 gm/hr.
Log Size		18 inches Max.

THE SPECTRUM

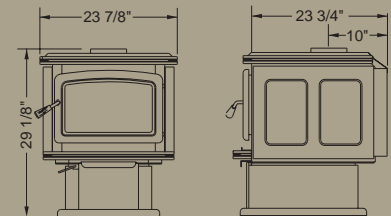

The Summit



Arched Door
– Gold



Arched Door
– Nickel



Arched Door
– Brushed Nickel



Arched Door
– Metallic Black



Crafted for maximum heating capacity, maximum burn time and maximum view of your wood fire, the Summit answers the call for a highly effective wood stove for bigger spaces and colder, longer nights.

STANDARD FEATURES

- Reliable, durable, non-catalytic technology
- Extended Burn Technology (EBT) See page 21
- Rich Metallic Black finish with black trim
- Straight in fuel loading
- Heavy plate-steel top
- 304 Stainless Steel baffle, insulation cover, rails and flame shield
- Inside and outside combustion air capable
- Mobile home approved

CHOICES

- Arched door in Gold, Nickel, Brushed Nickel or Metallic Black
- Metallic Black pedestal, or legs in four finishes: Gold, Nickel, Brushed Nickel or Metallic Black

OPTIONS

- Ash system
- Temperature actuated 125 cfm variable speed blower

Heating Capacity		3,000 sq.ft.*
HEAT OUTPUT	Cord Wood	97,000 BTU
	EPA Test Fuel	37,501 BTU
Efficiency		72.5%**
Emissions		3.56 gm/hr.
Log Size		20 inches Max.

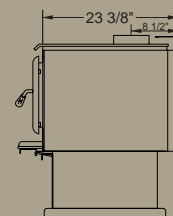
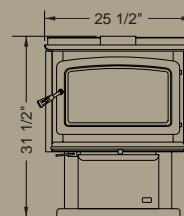

* Figures will vary depending on type of wood, floor plan, house layout, heat loss of home, and geographical location.
**Oregon DEQ results may vary due to wood size and moisture content.

The Super 27

'Arched' Doors

'Radiant' Doors

Gold



Nickel



Brushed Nickel



Metallic Black



Super Series Screen Door



Expand your burning season with a Super Series Screen Door, available for the Super 27, Spectrum, Spectrum Classic and Fusion Wood Stoves, and Pacific Wood Insert. Black Metallic finish with double handle design for easy placement and removal. Existing door may remain in place during Screen Door use.

design for easy placement and removal. Existing door may remain in place during Screen Door use.

Heating Capacity 2,000 sq.ft.*

HEAT OUTPUT	Cord Wood	72,000 BTU
	EPA Test Fuel	34,600 BTU

Efficiency 69.3%**

Emissions 3.4 gm/hr.

Log Size 18 inches Max.

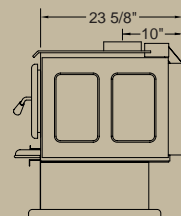
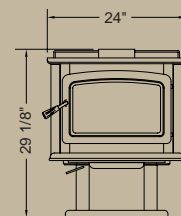

* Figures will vary depending on type of wood, floor plan, house layout, heat loss of home, and geographical location.
 **Oregon DEQ results may vary due to wood size and moisture content.

The Fusion



European inspired – North American priced. Bigger than its European cousins, The Fusion delivers easier loading, clean, efficient heat and longer burn times with Pacific Energy's proven Hi-Tech firebox.

Standing taller than most wood stoves, The Fusion gives you more view of the fire through its low-glare glass. The innovative design includes a wood storage chamber.

The Fusion is complemented by a Stainless Steel finish or a beautiful selection of lasting porcelain enamel colours.

FINISHES – PORCELAIN ENAMEL



Forest Green Ivory Ebony Sunset Red Royal Blue*

Pacific Energy's rich porcelain finish – perfectly suited to today's palette of warm interior colours.

**Royal Blue available as premium colour*

The Fusion

STANDARD FEATURES

- Boost air for easy lighting
- Long burn times
- User friendly, one-touch control
- Straight-in fuel loading
- Air wash system for super clean ceramic glass
- 304 Stainless Steel baffle, insulation cover, rails and flame shield
- Floating firebox design
- Reliable, durable non-catalytic technology
- Easy to use, ash disposal system
- Inside & outside combustion air compatible
- Mobile home approved

OPTIONS

- Temperature actuated 125 cfm variable speed blower with manual override
- Screen Door



FINISHES – STAINLESS STEEL



Clean, bright and contemporary, answers the call for a fresh look on woodstoves.

Heating Capacity		2,000 sq.ft.*
HEAT OUTPUT	Cord Wood	72,000 BTU
	EPA Test Fuel	34,600 BTU
Efficiency		69.3%**
Emissions		3.4 gm/hr.
Log Size		18 inches Max.

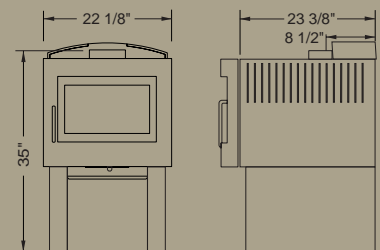

* Figures will vary depending on type of wood, floor plan, house layout, heat loss of home, and geographical location.

**Oregon DEQ results may vary due to wood size and moisture content.

The Summit Classic



PORCELAIN ENAMEL FINISH

The Summit Classic wood stoves are beautifully finished with a rich, vitreous porcelain enamel. This porcelain enamel possesses inherent qualities no other appliance finish can offer. It has the durability of steel, the scratch resistance of glass, and is virtually indestructible under everyday household use. And all five colours are guaranteed for life against fading. No special care is required to maintain its just-like-new appearance – simply wipe clean with a damp cloth.

See back cover for more about Porcelain Enamel.



Forest Green



Ivory



Royal Blue***

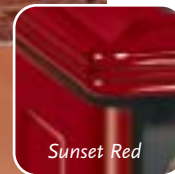

Sunset Red

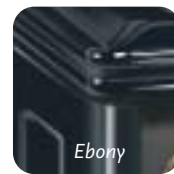

Ebony

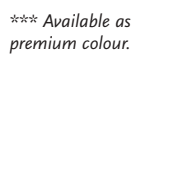

*** Available as premium colour.



Ash disposal is clean and easy with a removable ash drawer.

The Summit Classic Wood Stove, with patented Extended Burn Technology, has the power to keep you warm and comfortable throughout the night and the stamina to provide a bright, glowing fire with flaming logs to welcome you in the morning

STANDARD FEATURES

- Reliable, durable, non-catalytic technology
- Extended Burn Technology (EBT)
- Straight in fuel loading
- Heavy plate-steel top under decorative top
- 304 Stainless Steel baffle, rails, insulation cover & flame shield
- Porcelain Enamel finish
- Inside and outside combustion air capable
- Ash disposal system
- Mobile home approved

CHOICES

- Arched door is available in Gold, Nickel, Brushed Nickel or Metallic Black
- Legs available in Gold, Nickel, Brushed Nickel or Metallic Black
- Classic Trivet available in Gold, Nickel, Brushed Nickel or Metallic Black

OPTIONS

- Temperature actuated 125 cfm variable speed blower

Heating Capacity	3,000 sq.ft.*	
HEAT OUTPUT	Cord Wood	97,000 BTU
	EPA Test Fuel	37,501 BTU
Efficiency	72.5%**	
Emissions	3.56 gm/hr.	
Log Size	20 inches Max.	

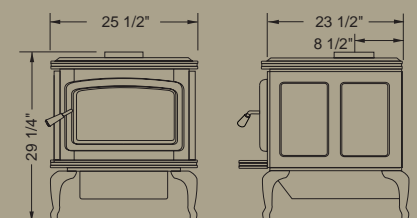

The Summit



Arched Door
– Gold



Arched Door
– Nickel



Arched Door
– Brushed Nickel



Arched Door
– Metallic Black



Crafted for maximum heating capacity, maximum burn time and maximum view of your wood fire, the Summit answers the call for a highly effective wood stove for bigger spaces and colder, longer nights.

STANDARD FEATURES

- Reliable, durable, non-catalytic technology
- Extended Burn Technology (EBT) See page 21
- Rich Metallic Black finish with black trim
- Straight in fuel loading
- Heavy plate-steel top
- 304 Stainless Steel baffle, insulation cover, rails and flame shield
- Inside and outside combustion air capable
- Mobile home approved

CHOICES

- Arched door in Gold, Nickel, Brushed Nickel or Metallic Black
- Metallic Black pedestal, or legs in four finishes: Gold, Nickel, Brushed Nickel or Metallic Black

OPTIONS

- Ash system
- Temperature actuated 125 cfm variable speed blower

Heating Capacity		3,000 sq.ft.*
HEAT OUTPUT	Cord Wood	97,000 BTU
	EPA Test Fuel	37,501 BTU
Efficiency		72.5%**
Emissions		3.56 gm/hr.
Log Size		20 inches Max.

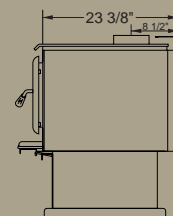
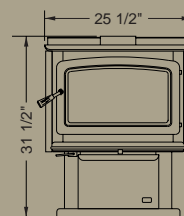

* Figures will vary depending on type of wood, floor plan, house layout, heat loss of home, and geographical location.
**Oregon DEQ results may vary due to wood size and moisture content.



Wood Fireplace Inserts

SMALL

For Heating up to 1500 sq ft.

The VISTA Insert

Weight: 300 lbs.



DESIGN ACCENTS



All Pacific Energy Wood Inserts are customizable in your choice of door finishes – Gold, Nickel, Metallic Black or Brushed Nickel.

The Surround Trim is available in Gold, Nickel or Metallic Black.

MEDIUM

For Heating up to 2000 sq ft.

The PACIFIC Insert

Weight: 410 lbs.



EXTENDED BURN TECHNOLOGY

A Summit loaded with wood will keep you warm for up to 10 hours, thanks to Extended Burn Technology (EBT). A patented innovation available only on Pacific Energy Summit Wood Stoves and Summit Inserts, EBT regulates combustion air flow, for a longer burn and more fuel economy. (See page 21 for more details.)

LARGE

For Heating up to 3100 sq ft.

The SUMMIT Insert

Weight: 450 lbs.



The Vista Insert

STANDARD FEATURES

- User friendly, one-touch fingertip control
- Internal "air-wash system" for super-clean ceramic glass
- 80 cfm temperature actuated blower
- Variable speed fan control
- Durable, non-catalytic technology
- Multi-port combustion air injection system
- Floating firebox design
- 304 Stainless Steel insulation cover

CHOICES

- Gold, Nickel, Brushed Nickel or Metallic Black arched door
- Embossed Surround
Standard size
(26.25"h x 36.5"w)
- Plain Surround
Oversized
(29.25"h x 42.5"w)

OPTIONS

- Mantel shield
- Hearth trim kit



The Vista Insert, the perfect solution for truly efficient, easy wood heat in smaller masonry or factory-built fireplaces. Pacific Energy's user-friendly design means controllable heat and a great view of your wood fire. Standard variable speed fan, clean glass "air wash system", floating firebox and heavy construction mean years of heating comfort.

DOOR FINISHES



Gold



Nickel



Brushed Nickel



Metallic Black

* Figures will vary depending on type of wood, floor plan, house layout, heat loss of home, and geographical location.
**Oregon DEQ results may vary due to wood size and moisture content.

Heating Capacity		1,500 sq.ft.*
HEAT OUTPUT	Cord Wood	56,000 BTU
	EPA Test Fuel	26,300 BTU
Efficiency		71.0%**
Emissions		2.9 gm/hr.
Log Size		18 inches Max.

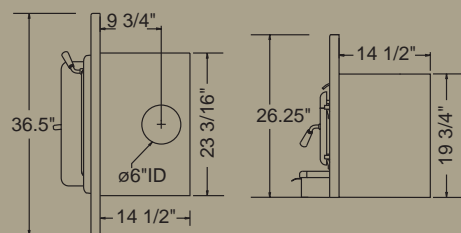

The Pacific Insert



STANDARD FEATURES

- Non-catalytic technology
- Multi-port combustion air injection system
- User friendly, one-touch fingertip control
- Internal "Air-Wash System" for super-clean ceramic glass
- 304 Stainless Steel baffle, insulation cover, rails and flame shield (See page 21)
- Easy installation
- Floating firebox components
- Straight-in loading for easier and safer refuelling
- 160 cfm temperature actuated blower
- Variable speed fan control

CHOICES

- Metallic Black arched or radiant door
- Gold arched or radiant door
- Nickel arched or radiant door
- Brushed Nickel arched or radiant door
- Embossed surround
 - Standard size (29" h x 42 3/4" w)
- Plain Surround
 - Oversized (33" h x 44 3/8" w)

OPTION

- Screen door



* Figures will vary depending on type of wood, floor plan, house layout, heat loss of home, and geographical location.

**Oregon DEQ results may vary due to wood size and moisture content.

Enjoy efficient heating without losing the ambience of an open fire. The Pacific Insert, with its large, ceramic glass door gives you the full comfort and view of your log fire, while delivering cost-effective heat and one-touch adjustable temperature control. Transform your drafty fireplace into an easy-to-light, easy-to-load efficient source of heat. The Pacific Insert firebox easily accommodates 18 inch logs and is designed for straight-in fuel loading for safe and simple operation.

Heating Capacity		2,000 sq.ft.*
HEAT OUTPUT	Cord Wood	72,000 BTU
	EPA Test Fuel	34,600 BTU
Efficiency		69.3%**
Emissions		3.4 gm/hr.
Log Size		18 inches Max.



Arched or Radiant Doors are available in Gold, Nickel, Brushed Nickel or Metallic Black.

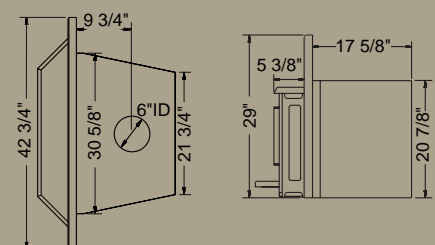

The Summit Insert

STANDARD FEATURES

- User friendly, one-touch operation
- Straight-in fuel loading for safer and easier refueling
- Internal "Air-Wash System" for super-clean, ceramic glass
- EBT (Extended Burn Technology)
- Temperature actuated 160cfm blower
- Variable speed fan control
- Temperature bypass switch
- 304 Stainless Steel baffle, insulation cover, rails and flame shield
- Inside and outside air combustion capable
- Durable, non-catalytic technology
- Floating firebox design

CHOICES

- Gold, Nickel, Brushed Nickel or Metallic Black arched door
- Embossed Surround
Standard size (48 3/4"w x 32"h)
- Plain Surround
Oversized (52 3/4"w x 34"h)

EXTENDED BURN TECHNOLOGY (EBT)

With EBT, a full load of wood will comfortably last throughout the night. EBT is available exclusively in Pacific Energy Summit Wood Stoves and Summit Fireplace Inserts. (See page 21)



Did you know that up to 80% of the heat from your open fireplace goes straight up your chimney? Pacific Energy's Summit Insert, the only insert with patented Extended Burn Technology gives you up to ten hours of burn for a full night of heat. The Summit Insert's extremely efficient Heat Extraction System transfers the maximum amount of heat to your room, over the longest time. And unlike an open fire, you control the heat output. A one-touch control quickly adjusts the heat to your desired comfort level.



Arched Doors are available in Gold, Nickel, Brushed Nickel or Metallic Black.

Heating Capacity		3,000 sq.ft.*
HEAT OUTPUT	Cord Wood	97,000 BTU
	EPA Test Fuel	37,501 BTU
Efficiency		72.5%**
Emissions		3.56 gm/hr.
Log Size		20 inches Max.

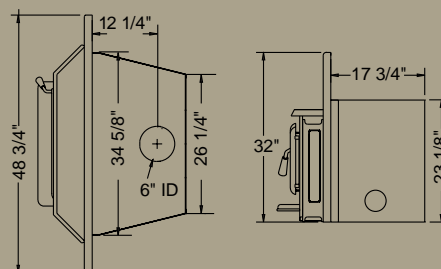



PACIFIC ENERGY

A HISTORY OF INNOVATION



Pacific Energy has constantly challenged, then exceeded the traditional assumptions about wood heat. Our history of innovation is evident in our industry-leading features, our choice of the finest materials, our close eye on environmental responsibility, and our commitment to creating efficient and convenient appliances that fit your style and warm your life.



The result is a series of industry firsts, accomplished through our on-going mission to provide you with the best possible wood burning technology.

First Glass Air Wash System

- because a beautiful fire should be seen

First Floating Firebox Design

- longer stove life with unrestricted thermal expansion

First Ash Removal System

- for quick, clean maintenance of your stove

First Extended Burn Technology

- maximum efficiency for longer burns

First in Porcelain

- Recognized by the Porcelain Enamel Institute, our porcelain is some of the best in the world. Pacific Energy porcelain enamel is lasting, rich and gem-like.



THE INDUSTRY'S BEST WARRANTY



Further proof of our commitment to quality and innovation is in the limited Lifetime Warranty on all Pacific Energy products. We know of no better guarantee in the hearth industry - for your assurance of warmth, and your peace of mind.

THE FLOATING FIREBOX

The Floating Firebox in your Pacific Energy wood stove or insert eliminates fatigue caused by expansion and contraction during heating and cooling. Many of the firebox components including the lifetime warranted baffle, the insulation cover, side rails and flame shield are manufactured with corrosion-resistant 304 Stainless Steel*. This combination of innovation and attention to detail dramatically extends the life of your appliance.

* All models except The Vista Series

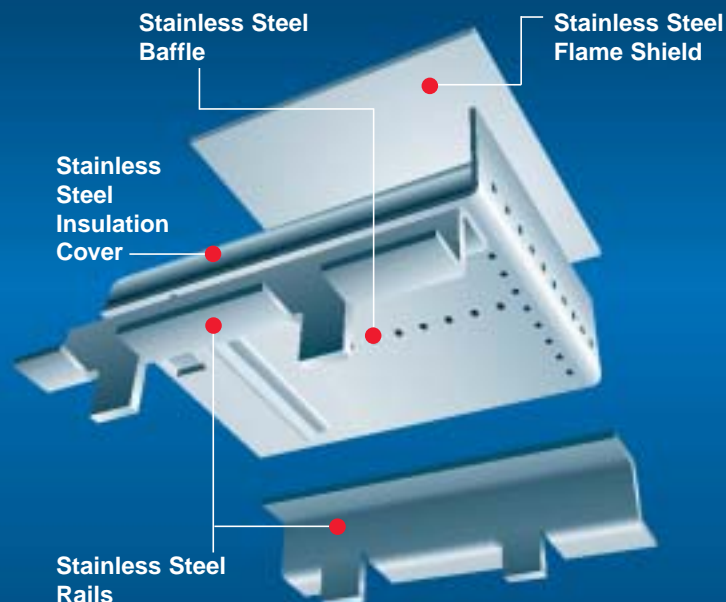

THE PACIFIC ENERGY INTEGRATED COMBUSTION SYSTEM

- 1 **BOOST AIR** Boost air provides a direct source of combustion air to the base of the fire.
- 2 **MAIN COMBUSTION AIR** Air introduced through the front air inlet is channelled upwards to the top air manifold. The manifold creates a curtain of air that sweeps downwards to enter the primary combustion zone at the base of the fire.
- 3 **AIR-WASH SYSTEM** The curtain of air created by the top air manifold acts as an air-wash system that prevents residue from coming into contact with the ceramic glass door, giving a clean, clear view of the log fire.
- 4 **SECONDARY COMBUSTION AIR** Air is fed into the hollow baffle through the rear supply tube. It passes through the baffle's perforations and into the firebox to mix with unburned gases and create secondary combustion. Air projected through the front perforations ignite any remaining gases to help reduce the emissions to a minimum.
- 5 **RADIANT HEAT** Radiant heat is projected from all surfaces of the stove and especially through the ceramic glass door. It travels in a straight line to heat everything in its path.
- 6 **CONVECTION HEAT** The natural convection cycle occurs when room air enters the space between the firebox and the heat shield and/or outer casing. As it travels upwards, it is heated before being projected into the room.

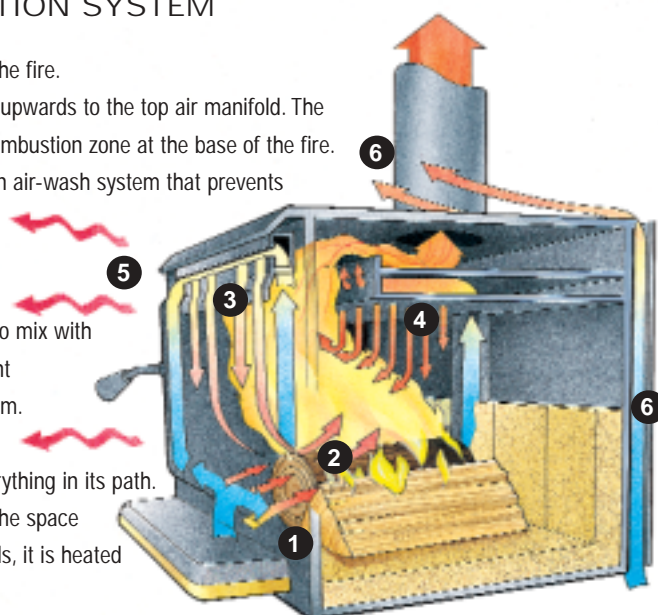

EXTENDED BURN TECHNOLOGY (EBT)

Pacific Energy's patented Extended Burn Technology is available exclusively on Summit Series wood stoves and inserts. The Summit Series, created for larger heating areas, comes equipped with EBT to regulate the flow of combustion air throughout the burn cycle and increase burn time. With EBT, your Summit wood stove or insert will burn longer between loads and give you more efficient fuel consumption.

US Patent #6,041,770

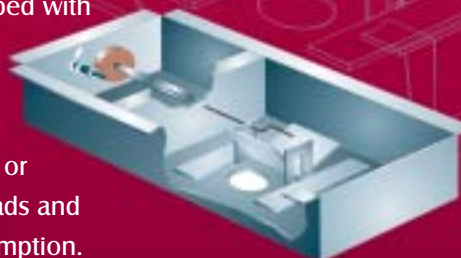
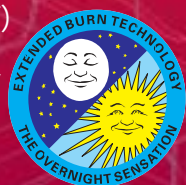

CLEAN HEAT

Pacific Energy demonstrates that wood heat and clean air can go hand in hand. Our combustion system produces less than half of the emissions allowed by the US Environmental Protection Agency and the Canadian B415 Standard.



FLOOR PROTECTOR

The charts shown below give the required dimensions of floor protector sizes based on various appliance installations.

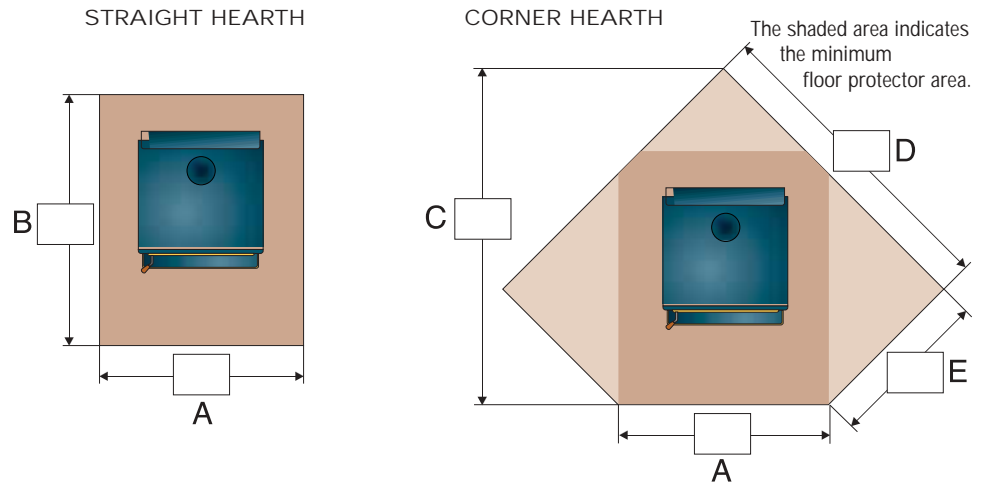

CANADA

Non-combustible ember protection must be used. (Check local building codes for acceptable construction materials.) This protection must be under the stove and must extend 18" on the firing side and 8" to the other sides.

STRAIGHT HEARTH (Extended to wall)

	VISTA / VISTA CLASSIC		SUPER 27 / SPECTRUM		SUMMIT / SUMMIT CLASSIC		FUSION	
	A	B	A	B	A	B	A	B
* Minimum	40"	43 1/4"	40"	50 1/2"	41 1/2"	51 1/8"	38 1/4"	50 1/2"
Residential, single wall, vertical connector	40"	50 1/4"	40"	54 1/2"	41 1/2"	52 1/8"	38 1/4"	56"
Residential, single wall, horizontal connector	40"	48 1/4"	40"	50 1/2"	41 1/2"	53 1/8"	38 1/4"	52"
Residential, double wall, vertical connector	40"	42 1/4"	40"	47 1/2"	41 1/2"	49 1/8"	38 1/4"	49"
Residential, double wall, horizontal connector	40"	42 1/4"	40"	47 1/2"	41 1/2"	53 1/8"	38 1/4"	49"
Alcove, double wall, connector	40"	46 1/4"	40"	52 1/2"	41 1/2"	52 1/8"	38 1/4"	54"
Mobile home	40"	47 1/4"	40"	50 1/2"	41 1/2"	50 1/8"	38 1/4"	52"

CORNER HEARTH (Extended to wall)

	VISTA / VISTA CLASSIC				SUPER 27 / SPECTRUM				SUMMIT / SUMMIT CLASSIC				FUSION			
	A	C	D	E	A	C	D	E	A	C	D	E	A	C	D	E
* Minimum	40"	58 1/8"	55 1/4"	27"	40"	63 5/8"	59 1/8"	30 7/8"	41 1/2"	63 5/8"	59 1/8"	30 7/8"	38 1/4"	64 7/8"	59 3/8"	32 3/8"
Residential, single wall, vert/horz connector	40"	60 7/8"	57 1/4"	29"	40"	67 7/8"	62 1/8"	33 7/8"	41 1/2"	61"	57 3/4"	28 3/8"	38 1/4"	69 1/2"	62 5/8"	35 5/8"
Residential, double wall, vert/horz connector	40"	51"	50 1/4"	22"	40"	58"	55 1/8"	26 7/8"	41 1/2"	61"	57 3/4"	28 3/8"	38 1/4"	59 5/8"	55 5/8"	28 5/8"
Mobile home	40"	58 1/8"	55 1/4"	27"	40"	63 5/8"	59 1/8"	30 7/8"	41 1/2"	62 3/8"	58 3/4"	29 3/8"	38 1/4"	65 1/4"	59 5/8"	32 5/8"

USA

Non-combustible ember protection must be used. (Check local building codes for acceptable construction materials.) This protection must be under the stove and must extend 16" to the front and 8" to the sides of the fuel loading door opening. This protection is also required under the chimney connector and 2" beyond each side.

STRAIGHT HEARTH (Extended to wall)

	VISTA / VISTA CLASSIC		SUPER 27 / SPECTRUM		SUMMIT / SUMMIT CLASSIC		FUSION	
	A	B	A	B	A	B	A	B
* Minimum	32"	33 1/4"	34"	40 1/2"	36"	40 1/2"	34"	40 1/2"
Residential, single wall, vertical connector	32"	48 1/4"	34"	52 1/2"	36"	49 1/2"	34"	54"
Residential, single wall, horizontal connector	32"	46 1/4"	34"	48 1/2"	36"	50 1/2"	34"	50"
Residential, double wall, vertical connector	32"	40 1/4"	34"	45 1/2"	36"	46 1/2"	34"	47"
Residential, double wall, horizontal connector	32"	40 1/4"	34"	45 1/2"	36"	50 1/2"	34"	47"
Alcove, double wall, connector	32"	44 1/4"	34"	50 1/2"	36"	49 1/2"	34"	52"
Mobile home	32"	45 1/4"	34"	48 1/2"	36"	47 1/2"	34"	50"

CORNER HEARTH (Extended to wall)

	VISTA / VISTA CLASSIC				SUPER 27 / SPECTRUM				SUMMIT / SUMMIT CLASSIC				FUSION			
	A	C	D	E	A	C	D	E	A	C	D	E	A	C	D	E
* Minimum	32"	53 1/4"	50 3/8"	25"	34"	49 7/8"	47 3/8"	23 1/4"	36"	53 1/4"	50 3/8"	25"	34"	51 5/8"	48 1/2"	24 1/2"
Residential, single wall, vert/horz connector	32"	58 7/8"	53"	30 3/8"	34"	65 7/8"	58 3/8"	34 1/4"	36"	59"	54 3/8"	29"	34"	67 1/2"	59 3/4"	35 3/4"
Residential, double wall, vert/horz connector	32"	49"	46"	23 3/8"	34"	55 5/8"	51 3/8"	27 1/4"	36"	59"	54 3/8"	29"	34"	57 5/8"	52 3/4"	28 3/4"
Mobile home	32"	56 1/8"	51"	28 3/8"	34"	61 1/4"	55 3/8"	31 1/4"	36"	60 3/8"	55 3/8"	30"	34"	63 1/4"	56 3/4"	32 3/4"

Note: In most practical applications the floor protection will extend to the back wall. In Canada and U.S.A. it is not required that the floor protection extend to the wall and in such cases floor protector sizes may vary slightly. Please refer to manual for details. Manuals are available on our website: www.pacificenergy.net

WOOD STOVES – MINIMUM CLEARANCES TO COMBUSTIBLES

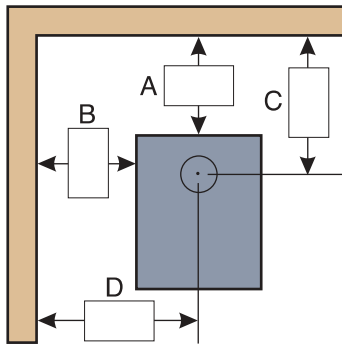

STRAIGHT

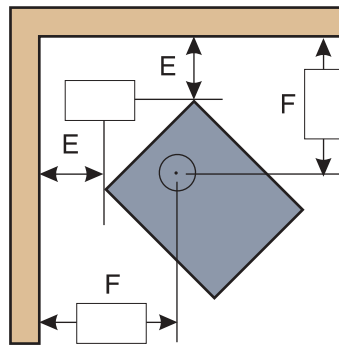

CORNER

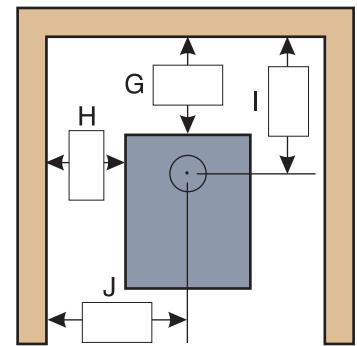

ALCOVE

RESIDENTIAL		SINGLE WALL CONNECTOR*								* Pipe shield may be required – consult local codes					
		Straight Installation Vertical Connector				Straight Installation Horizontal Connector				Corner Installation		Alcove Installation			
MODEL	From top of stove to ceiling	A	B	C	D	A	B	C	D	E	F	G	H	I	J
VISTA / VISTA CLASSIC	58"	15"	14"	20 3/4"	26"	13"	14"	18 3/4"	26"	10"	22 5/8"	–	–	–	–
SUPER 27 / SPECTRUM	56"	12"	18"	22"	30"	8"	14"	18"	26"	11"	25"	–	–	–	–
SUMMIT / SUMMIT CLASSIC	54"	9"	12"	17 1/2"	24 3/4"	10"	12"	18 1/2"	24 3/4"	4"	18 3/4"	–	–	–	–
FUSION	50 1/2"	13 1/2"	19"	22"	30"	9 1/2"	15"	18"	26"	11 1/4"	25"	–	–	–	–

RESIDENTIAL		DOUBLE WALL CONNECTOR													
		Straight Installation Vertical Connector				Straight Installation Horizontal Connector				Corner Installation		Alcove Installation **			
MODEL	From top of stove to ceiling	A	B	C	D	A	B	C	D	E	F	G	H	I	J
VISTA / VISTA CLASSIC	58"	7"	12"	12 3/4"	24"	7"	12"	12 3/4"	24"	3"	15 5/8"	11"	12"	16 3/4"	24"
SUPER 27 / SPECTRUM	56"	5"	14"	15"	26"	5"	14"	15"	26"	4"	18"	10"	16"	20"	28"
SUMMIT / SUMMIT CLASSIC	54"	6"	12"	14 1/2"	24 3/4"	10"	12"	18 1/2"	24 3/4"	4"	18 3/4"	9"	15"	17 1/2"	27 3/4"
FUSION	50 1/2"	6 1/2"	15"	15"	26"	6 1/2"	15"	15"	26"	4 1/4"	18"	11 1/2"	17"	20"	28"

** Please refer to manuals for minimum height and maximum depth of alcove.

MOBILE HOME		DOUBLE WALL CONNECTOR													
		Straight Installation Vertical Connector				Straight Installation Horizontal Connector				Corner Installation		Alcove Installation			
MODEL	From top of stove to ceiling	A	B	C	D	A	B	C	D	E	F	G	H	I	J
VISTA / VISTA CLASSIC	58"	12"	12"	17 3/4"	24"	12"	12"	17 3/4"	24"	8"	20 5/8"	–	–	–	–
SUPER 27 / SPECTRUM	56"	8"	16"	18"	28"	8"	16"	18"	28"	8"	22"	–	–	–	–
SUMMIT / SUMMIT CLASSIC	54"	7"	14"	15 1/2"	26 3/4"	7"	14"	15 1/2"	26 3/4"	5"	19 3/4"	–	–	–	–
FUSION	50 1/2"	9 1/2"	17"	18"	28"	9 1/2"	17"	18"	28"	8 1/4"	22"	–	–	–	–

WOOD INSERTS – MINIMUM CLEARANCES TO COMBUSTIBLES

MODEL	A	B	C
VISTA WOOD INSERT	9"	29 1/2"	9"
VISTA WOOD INSERT (With Mantel Shield)	9"	18 1/2"	9"
PACIFIC WOOD INSERT	6 1/2"	24"	20 1/2"
SUMMIT WOOD INSERT	8 1/2"	21"	8 1/2"

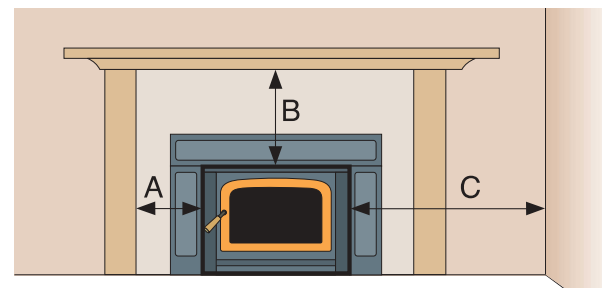

PORCELAIN ~ THE CLASSIC FINISH

The Ibis and other fine jewelry of Tutankhamen were enamelled over 3000 years ago, yet stand the test of time.

The Ibis



The lasting beauty of Porcelain Enamel continues to be crafted with care today on Pacific Energy wood stoves and fireplaces.



3 A thin layer of slip is sprayed on the components. Over-spray is captured in a closed loop system and recycled.

4 Next, the coated components are hung on a conveyor and enter the forced air dryer to remove moisture.



1 We combine finely ground silica glass, or frit, with colour oxides and water. The precise combination of these ingredients creates a slip that is the perfect consistency for spraying on our metal stove components.



2 Our stove parts are fabricated from premium low carbon steel that is cleaned, then phosphate coated to inhibit oxidation.

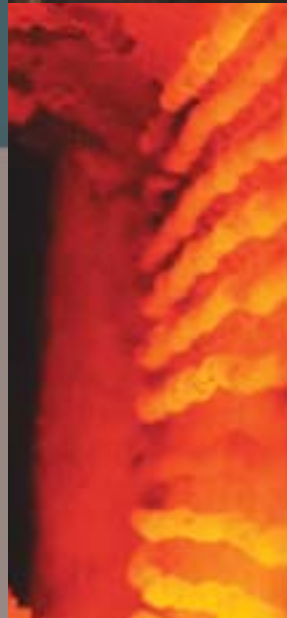

5 The components enter a flow-through furnace where temperatures in the 1500°F range bind steel and enamel slip to create a new compound – Porcelain Steel.

From beginning to end, a Pacific Energy stove is made with care for the environment, a hands-on manufacturing process and pride in a unique product.



PACIFIC ENERGY
FIREPLACE PRODUCTS LTD.

www.pacificenergy.net
1 888 223-0088

