

TOP VIEW

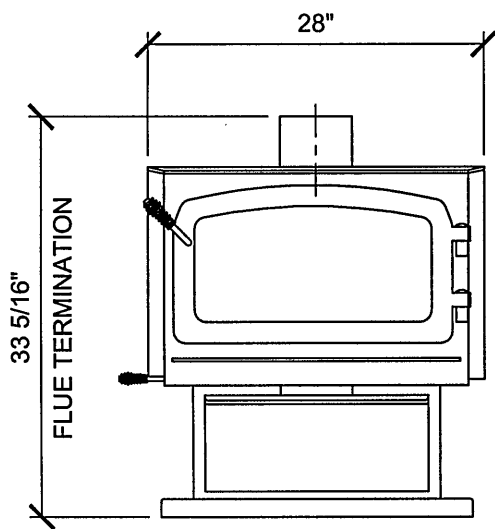

FRONT VIEW

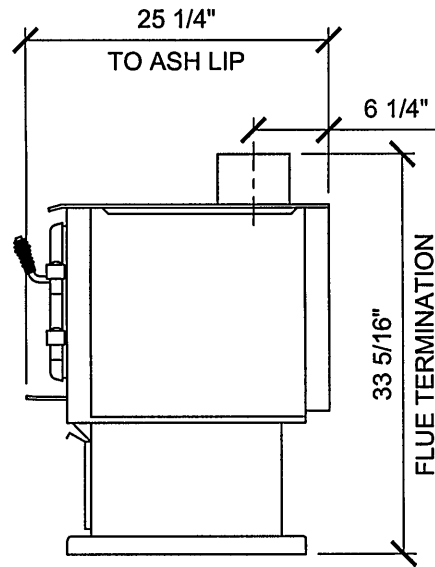

SIDE VIEW

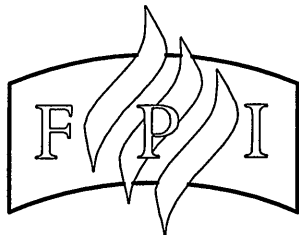

PROJECT TITLE:

FPI FIREPLACE PRODUCTS
INTERNATIONAL LTD.

SHEET TITLE:

REGENCY FREESTANDING
WOOD STOVE - F3100 WITH PEDESTAL

DATE:

FEB. 2005

DRAWN:

U.D.S. Ltd.

DESIGNED:

U.D.S. Ltd.

APPROVED:

DRAWING No.:

1 of 1

F3100

REV.: 0