



2011/12

CAST IRON WOOD STOVES & INSERTS

— Where Tradition, Craftsmanship and Performance meet. —



It all began in the 1880's

when the community of Alderlea was just a whistle stop on Canada's rugged West Coast — today those early days of Alderlea live on in what is now the Cowichan Valley, home to Pacific Energy.

Alderlea woodstoves have redefined the centuries-old charm of the cast iron stove by wrapping a graceful cast iron profile around legendary Pacific Energy steel fireboxes. This innovation delivers both radiant and convection heat for powerful performance.

In true pioneer style, The Alderlea has a practical side – a large concealed cook top, food warming shelves, an air-wash for a clear view of the fire, and an easy cleaning innovative ash disposal system.

Powered by Pacific Energy's proven steel fireboxes, the Alderlea collection will provide many years of low-maintenance operation, while delivering the ease of use and exceptional heat that comes with over 30 years of woodburning experience.

For your assurance of warmth and peace of mind, we further our commitment to quality and innovation with Pacific Energy's Limited Lifetime Warranty—we know of no better cast iron woodstove guarantee.

Alderlea T4	4-5
Alderlea T5.....	6-7
Alderlea T6.....	8-9
Alderlea T5 Insert.....	10-11
Floor Protectors.....	12
Minimum Clearances	13
A History of Innovation.....	14
Efficient Wood Heating	15



Alderlea T5

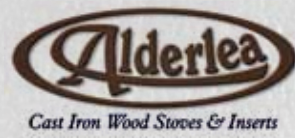

What is BTU?

The British thermal unit (symbol BTU or Btu) is a traditional unit of energy equal to about 1,055 joules. It is approximately the amount of energy needed to heat 1 pound (0.454 kg) of water (i.e. exactly one tenth of a UK gallon, or around 0.1198 US gallons) from 39 to 40 ° F (3.8 to 4.4° C).

In North America, the term "BTU" is used to describe the heat value (energy content) of fuels, and also to describe the power of heating and cooling systems, such as furnaces, stoves, barbecue grills, and air conditioners.

What is the difference between EPA test fuel and cord wood?

All wood is not created equal and burn results vary due to the type of wood, its density and its moisture content. To reduce burn rate variations, the EPA has developed a standardized wood load for testing. Uniform pieces of Douglas Fir lumber, with specific moisture content, are stacked into a precise configuration to minimize any fluctuations caused by volume and wood type.

* Heating Capacity will vary depending on type of wood, floor plan, house layout, heat loss of home, and geographical location.

SMALL STOVES

Alderlea T4 Series

Firebox Size: 1.5 cubic ft
For heating up to 1500 sq. ft.



Alderlea T4

Heat Output*	
Cord Wood	56,000 BTU
EPA Test Fuel	26,300 BTU

Efficiency (LHV) 80.7%

Emissions 2.9 gm/hr.

Log Size (max) 18 inches

For Spaces up to 1500 square feet.

Alderlea T4 Classic

Heat Output*	
Cord Wood	56,000 BTU
EPA Test Fuel	26,300 BTU

Efficiency (LHV) 80.7%

Emissions 2.9 gm/hr.

Log Size (max) 18 inches

For Spaces up to 1500 square feet.

→ Page 4

MEDIUM STOVES

Alderlea T5 Series

Firebox Size: 2.1 cubic ft
For heating up to 2000 sq. ft.



Alderlea T5

Heat Output*	
Cord Wood	72,000 BTU
EPA Test Fuel	34,600 BTU

Efficiency (LHV) 82.6%

Emissions 3.4 gm/hr.

Log Size (max) 18 inches

For Spaces up to 2000 square feet.

Alderlea T5 Classic

Heat Output*	
Cord Wood	72,000 BTU
EPA Test Fuel	34,600 BTU

Efficiency (LHV) 82.6%

Emissions 3.4 gm/hr.

Log Size (max) 18 inches

For Spaces up to 2000 square feet.

→ Page 6

LARGE STOVES

Alderlea T6

Firebox Size: 3.0 cubic ft.
For heating up to 3000 sq. ft.



Alderlea T6

Heat Output*	
Cord Wood	99,000 BTU
EPA Test Fuel	38,500 BTU

Efficiency (LHV) 80.4%

Emissions 3.9 gm/hr.

Log Size (max) 18-20 inches

For Spaces up to 3000 square feet.

→ Page 8

INSERTS

Alderlea T5 Series

Firebox Size: 2.1 cubic ft
For heating up to 2000 sq. ft.



Alderlea T5

Heat Output*	
Cord Wood	72,000 BTU
EPA Test Fuel	34,600 BTU

Efficiency (LHV) 82.6%

Emissions 3.4 gm/hr.

Log Size (max) 18 inches

For Spaces up to 2000 square feet.

→ Page 10

Alderlea T5 Classic

Heat Output*	
Cord Wood	72,000 BTU
EPA Test Fuel	34,600 BTU

Efficiency (LHV) 82.6%

Emissions 3.4 gm/hr.

Log Size (max) 18 inches

For Spaces up to 2000 square feet.



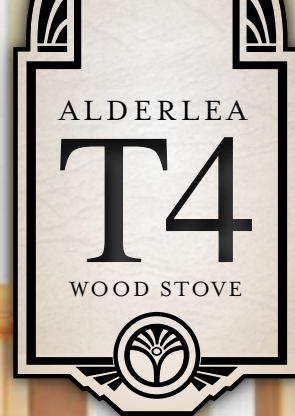

The radiant heat of cast iron combined with the convective warmth of steel. The T4 is designed for spaces up to 1500 ft².

HEAT OUTPUT



EFFICIENCY/EMISSIONS

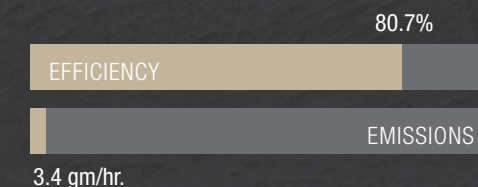

HEATING CAPACITY	1,500 sq.ft.
LOG SIZE (max)	18 in.
FIREBOX SIZE	1.5 Cubic ft.
FLUE DIAMETER	6 in.

STANDARD FEATURES

- Pacific Energy's legendary steel firebox
- Reliable, durable, non-catalytic technology
- Industry-leading limited lifetime warranty
- Rich metallic black cast iron, Majolica or Ebony porcelain enamel finish
- Floating firebox for extended stove life
- Air wash system for super clean glass
- Concealed cook top, fits 6" x 13" pan
- Swing out food warming shelves
- Easy cleaning innovative ash system and chute
- Close wall clearances, without added expense of heat shields
- Steel baffle and 304 Stainless Steel insulation cover
- Inside and outside combustion air capable
- Mobile home approved

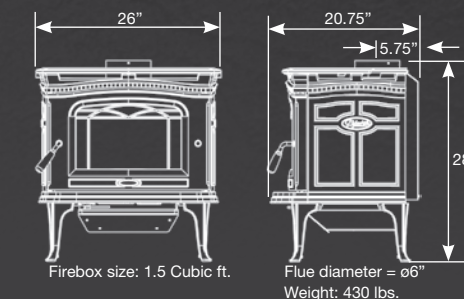

OPTIONS

- Temperature actuated 125 cfm variable speed blower
- Right swing door available*
- Screen Door



*only available on metallic cast iron finish

FINISHES | COLOURS

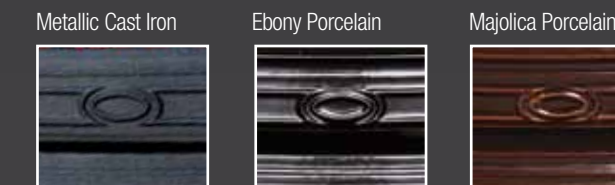

The Alderlea T4 in historic cast iron incorporates all the outstanding features of the larger Alderlea woodstoves - huge glass for a full view of the fire, a cook top for peace of mind

during power outages, powerful heat output, a high efficiency rating, and user friendly operation. An effective heater with old world charm.

ALDERLEA T4 • Classic

The timeless beauty of the cast iron stove combined with legendary Pacific Energy Firebox technology allows you to heat your home with maximum strength and unmatched durability. Gracefully clad in a choice of two lustrous porcelain enamel finishes, the T4 Classic is big on performance and style.



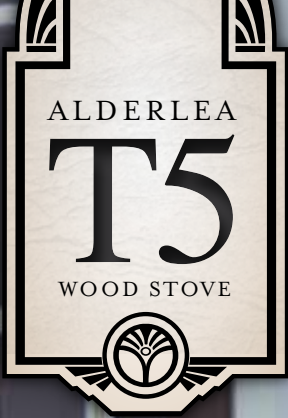

Built around Pacific Energy's legendary Super Series steel firebox, the Alderlea T5 combines the very best features of both cast iron and steel stoves. Beauty and strength.

HEAT OUTPUT



72000 BTU
34600 BTU (EPA Test Fuel)

EFFICIENCY/EMISSIONS

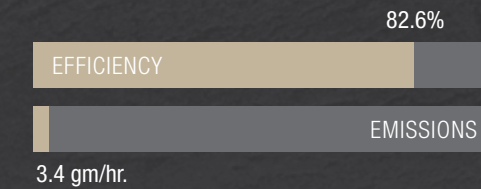

HEATING CAPACITY 2,000 sq.ft.
LOG SIZE (max) 18 in.
FIREBOX SIZE 2.1 Cubic ft.
FLUE DIAMETER 6 in.

STANDARD FEATURES

- Pacific Energy's legendary steel firebox
- Reliable, durable, non-catalytic technology
- Industry-leading limited lifetime warranty
- Rich Metallic Black cast iron, Majolica or Ebony porcelain enamel finish
- Floating firebox for extended stove life
- Air wash system for super clean glass
- Concealed cook top, fits 9" x 11" pan
- Swing out food warming shelves
- Easy cleaning innovative ash system and chute
- Close wall clearances, without added expense of heat shields
- 304 Stainless Steel baffle, insulation cover and flame shield
- Inside and outside combustion air capable
- Mobile home approved

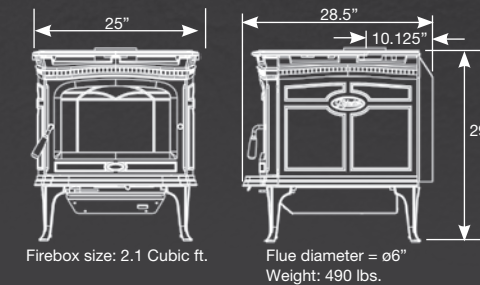

OPTIONS

- Temperature actuated 125 cfm variable speed blower
- Right swing door available*
- Screen Door



*only available on metallic cast iron finish

FINISHES | COLOURS

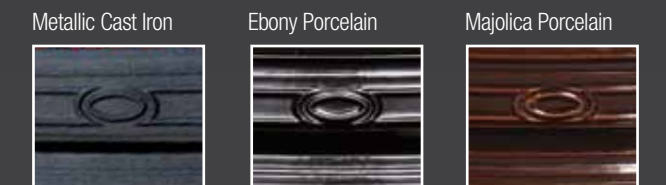

Elegant, historic cast iron styling that adds to the decor of any room, the T5 offers radiant and convective heat, a huge glass for a full view of your fire, a concealed cook top

for peace of mind during power outages, easy-lighting, all in a proven clean, long-burning heater with 30 years of wood stove technology behind it.

ALDERLEA T5 • Classic

Our best selling Alderlea T5 is now wrapped in your choice of Majolica or Ebony porcelain enamel. The jewel like finish adds another outstanding choice to an already outstanding list of performance and design features. Enjoy years of carefree warmth with an easy-to-light, easy-to-load reliable source of heat.



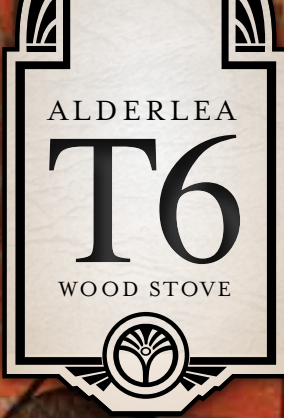

Patented Extended Burn Technology (EBT) gives the Alderlea T6, the largest of the Alderlea cast iron stoves, all-night burns with maximum heating capacity.

HEAT OUTPUT



EFFICIENCY/EMISSIONS

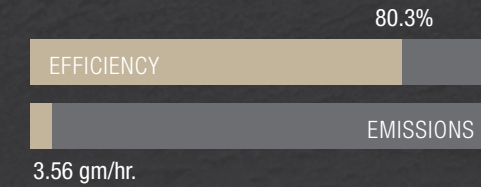

HEATING CAPACITY	3,000 sq.ft.
LOG SIZE (max)	18–20 in.
FIREBOX SIZE	3.0 Cubic ft.
FLUE DIAMETER	6 in.

STANDARD FEATURES

- Pacific Energy's legendary steel firebox
- Reliable, durable, non-catalytic technology
- Industry-leading limited lifetime warranty
- Rich metallic black cast iron finish
- Floating firebox for extended stove life
- Air wash system for super clean glass
- Extended Burn Technology (EBT)
- Concealed cook top, fits 12" x 15" pan
- Swing out food warming shelves
- Easy cleaning innovative ash system and chute
- Close wall clearances, without added expense of heat shields
- 304 Stainless Steel baffle, insulation cover and flame shield
- Inside and outside combustion air capable
- Mobile home approved

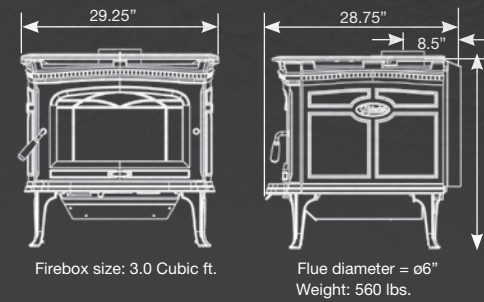

OPTIONS

- Temperature actuated 125 cfm variable speed blower
- Right swing door available
- Screen Door



FINISHES | COLOURS

Cast Iron



Huge glass opens up the view of your fire. Large cook top surface comfortably fits a large casserole pan with warming space to spare. The Alderlea T6, and all Pacific

Energy wood stove products, are backed by our Limited Lifetime Warranty – our promise of many years of wood heat comfort.



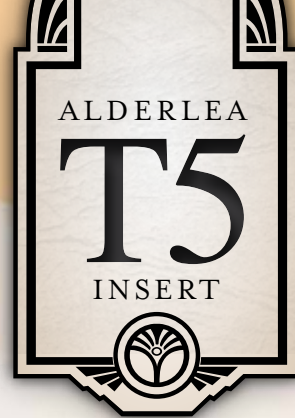

Transform your fireplace into an efficient heating system with the Alderlea T5 Insert.

HEAT OUTPUT



72000 BTU
34600 BTU (EPA Test Fuel)

EFFICIENCY/EMISSIONS

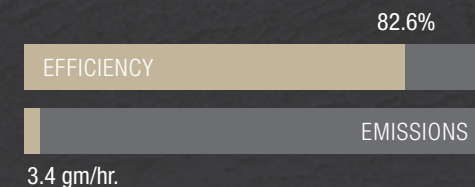

HEATING CAPACITY 2,000 sq.ft.
LOG SIZE (max) 18 in.
FIREBOX SIZE 2.1 Cubic ft.
FLUE DIAMETER 6 in.

STANDARD FEATURES

- Pacific Energy's legendary steel firebox
- Reliable, durable, non-catalytic technology
- Industry-leading limited lifetime warranty
- Rich Metallic Black cast iron, Majolica or Ebony porcelain enamel finish
- Air wash system for super clean glass
- Temperature actuated 160 cfm variable speed blowers
- User friendly one-touch control
- Easier, safer straight in loading
- Stainless steel floating firebox components for longer life
- Inside and outside combustion air capable

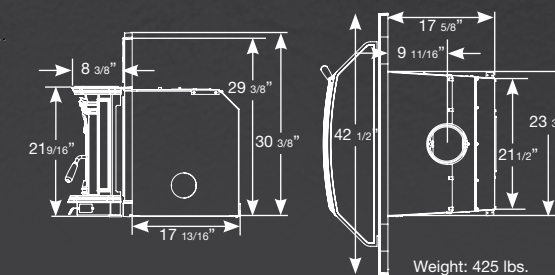

OPTIONS

- Temperature actuated 125 cfm variable speed blower
- Screen Door
- Oversized Surround Top (42 1/2" W x 34 1/8" H)
- Standard Surround Top (42 1/2" W x 30 3/8" H)



FINISHES | COLOURS

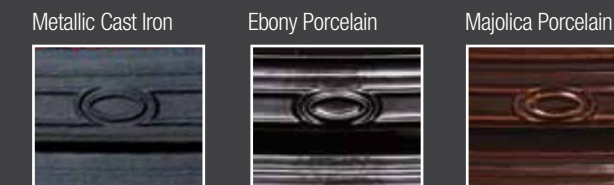

Elegant, traditional cast iron styling combined with a clean glass door and legendary Pacific Energy performance, are sure to make this into the coziest room in your house.

ALDERLEA T5
Classic
INSERT

Heat beautifully and efficiently with the charm of cast iron clad in lustrous porcelain enamel. With two rich, porcelain enamel finishes to choose from, Majolica or Ebony, the Alderlea T5 Classic Insert is a striking design option to heat any space.



AVAILABLE EARLY 2012

FLOOR PROTECTOR

The charts shown below give the required dimensions of floor protector sizes based on various appliance installations.

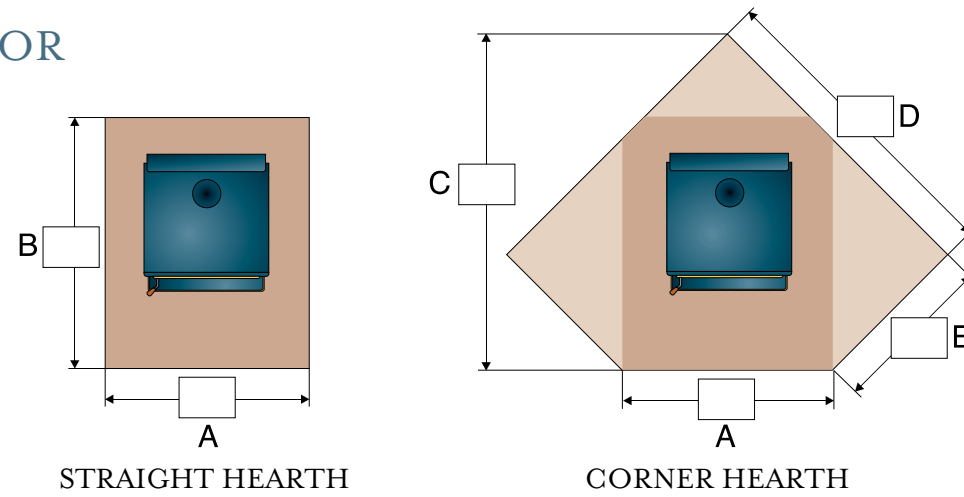

STRAIGHT HEARTH

CORNER HEARTH

CANADA

Non-combustible ember protection must be used. (Check local building codes for acceptable construction materials.) This protection must be under the stove and must extend 18" on the firing side and 8" to the other sides.

STRAIGHT HEARTH

(Extended to wall unless noted)

	ALDERLEA T4		ALDERLEA T5		ALDERLEA T6	
	A	B	A	B	A	B
Minimum (Not extended)	40"	43 1/4"	40"	50 1/2"	43"	54 3/4"
Residential, single wall, vertical connector	40"	50 1/4"	40"	54 1/2"	43"	55 3/4"
Residential, single wall, horizontal connector	40"	48 1/4"	40"	50 1/2"	43"	55 3/4"
Residential, double wall, vertical connector	40"	42 1/4"	40"	47 1/2"	43"	54 3/4"
Residential, double wall, horizontal connector	40"	42 1/4"	40"	47 1/2"	43"	54 3/4"
Alcove, double wall, connector	40"	46 1/4"	40"	52 1/2"	43"	56 3/4"
Mobile home	40"	47 1/4"	40"	50 1/2"	43"	56 3/4"

CORNER HEARTH

(Extended to wall unless noted)

	ALDERLEA T4				ALDERLEA T5				ALDERLEA T6			
	A	C	D	E	A	C	D	E	A	C	D	E
Minimum (Not extended)	40"	58 1/8"	55 1/4"	27"	40"	63 5/8"	59 1/8"	30 7/8"	43"	69"	64"	33 1/2"
Residential, single wall, vert/horz connector	40"	60 7/8"	57 1/4"	29"	40"	67 7/8"	62 1/8"	33 7/8"	43"	66"	62"	31 1/2"
Residential, double wall, vert/horz connector	40"	51"	50 1/4"	22"	40"	58"	55 1/8"	26 7/8"	43"	64 3/4"	61"	30 1/2"
Mobile home	40"	58 1/8"	55 1/4"	27"	40"	63 5/8"	59 1/8"	30 7/8"	43"	69"	64"	33 1/2"

USA

Non-combustible ember protection must be used. (Check local building codes for acceptable construction materials.) This protection must be under the stove and must extend 16" to the front and 8" to the sides of the fuel loading door opening. This protection is also required under the chimney connector and 2" beyond each side.

STRAIGHT HEARTH

(Extended to wall unless noted)

	ALDERLEA T4		ALDERLEA T5		ALDERLEA T6	
	A	B	A	B	A	B
Minimum (Not extended)	32"	33 1/4"	34"	40 1/2"	35"	40 1/2"
Residential, single wall, vertical connector	32"	48 1/4"	34"	52 1/2"	35"	49 1/2"
Residential, single wall, horizontal connector	32"	46 1/4"	34"	48 1/2"	35"	49 1/2"
Residential, double wall, vertical connector	32"	40 1/4"	34"	45 1/2"	35"	48"
Residential, double wall, horizontal connector	32"	40 1/4"	34"	45 1/2"	35"	48"
Alcove, double wall, connector	32"	44 1/4"	34"	50 1/2"	35"	50 1/2"
Mobile home	32"	45 1/4"	34"	48 1/2"	35"	50 1/2"

CORNER HEARTH

(Extended to wall unless noted)

	ALDERLEA T4				ALDERLEA T5				ALDERLEA T6			
	A	C	D	E	A	C	D	E	A	C	D	E
Minimum (Not extended)	32"	53 1/4"	50 3/8"	25"	34"	49 7/8"	47 3/8"	23 1/4"	35"	62 3/4"	56 3/4"	32"
Residential, single wall, vert/horz connector	32"	58 7/8"	53"	30 3/8"	34"	65 7/8"	58 3/8"	34 1/4"	35"	60"	54 3/4"	30"
Residential, double wall, vert/horz connector	32"	49"	46"	23 3/8"	34"	55 5/8"	51 3/8"	27 1/4"	35"	58 1/2"	53 3/4"	29"
Mobile home	32"	56 1/8"	51"	28 3/8"	34"	61 1/4"	55 3/8"	31 1/4"	35"	62 3/4"	56 3/4"	32"

Note: In most practical applications the floor protection will extend to the back wall. In Canada and U.S.A. it is not required that the floor protection extend to the wall and in such cases floor protector sizes may vary slightly. Please refer to manual for details. Manuals are available on our website: www.pacificenergy.net

MINIMUM CLEARANCES TO COMBUSTIBLES

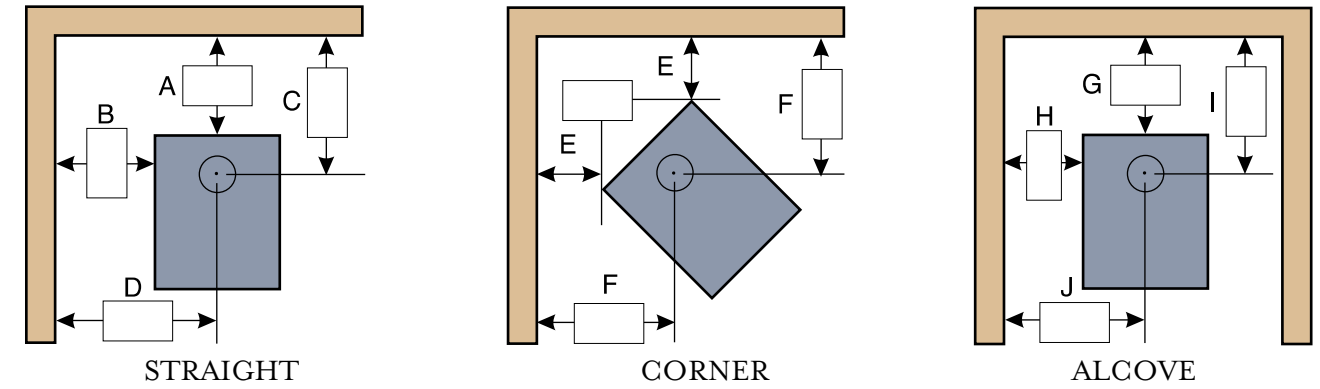

STRAIGHT

CORNER

ALCOVE

RESIDENTIAL

SINGLE WALL CONNECTOR*

* Pipe shield may be required – consult local codes

MODEL	From top of stove to ceiling	Straight Installation Vertical Connector				Straight Installation Horizontal Connector				Corner Installation		Alcove Installation			
		A	B	C	D	A	B	C	D	E	F	G	H	I	J
T4	56 3/4" (1441 mm)	15"	14"	20 3/4"	26"	13"	14"	18 3/4"	26"	10"	22 5/8"	N/A	N/A	N/A	N/A
T5	55 1/4" (1403 mm)	12"	18"	22"	30"	8"	14"	18"	26"	11"	25"	N/A	N/A	N/A	N/A
T6	56 1/2" (1409 mm)	9"	14"	17 3/4"	28 3/4"	9"	14"	17 3/4"	28 3/4"	6"	20 1/4"	N/A	N/A	N/A	N/A

RESIDENTIAL

DOUBLE WALL CONNECTOR

MODEL	From top of stove to ceiling	Straight Installation Vertical Connector				Straight Installation Horizontal Connector				Corner Installation		Alcove Installation**			
		A	B	C	D	A	B	C	D	E	F	G	H	I	J
T4	56 3/4" (1441 mm)	7"	12"	12 3/4"	24"	7"	12"	12 3/4"	24"	3"	15 5/8"	11"	12"	16 3/4"	24"
T5	55 1/4" (1403 mm)	5"	14"	15"	26"	5"	14"	15"	26"	4"	18"	10"	16"	20"	28"
T6	56 1/2" (1409 mm)	7 1/2"	13"	16 1/4"	27 3/4"	7 1/2"	13"	16 1/4"	27 3/4"	5"	19 1/4"	10"	16"	18 3/4"	30 3/4"

** Please refer to manuals for minimum height and maximum depth of alcove.

MOBILE HOME

DOUBLE WALL CONNECTOR

MODEL	From top of stove to ceiling	Straight Installation Vertical Connector				Straight Installation Horizontal Connector				Corner Installation		Alcove Installation			
		A	B	C	D	A	B	C	D	E	F	G	H	I	J
T4	56 3/4" (1441 mm)	12"	12"	17 3/4"	24"	N/A	N/A	N/A	N/A	8"	20 5/8"	N/A	N/A	N/A	N/A
T5	55 1/4" (1403 mm)	8"	16"	18"	28"	N/A	N/A	N/A	N/A	8"	22"	N/A	N/A	N/A	N/A
T6	56 1/2" (1409 mm)	10"	18"	18 3/4"	32 3/4"	N/A	N/A	N/A	N/A	8"	22 1/4"	N/A	N/A	N/A	N/A

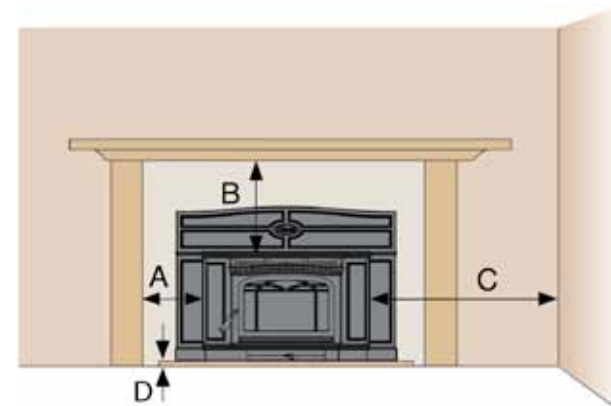

Minimum clearances to combustibles (Measured from insert body)		
A	Side facing	6.5 in. 165 mm
B	Mantel	16 in. 406 mm
C	Adjacent Side Wal	20.5 in. 521 mm
D	Fireplace Hearth Pad	2 in. 51 mm

A History of Innovation

For more than 30 years Pacific Energy has challenged, then exceeded the traditional assumptions about wood heat. Our history of innovation is evident in our industry-leading features, our choice of the finest materials, our close eye on environmental responsibility, and our commitment to creating efficient and convenient appliances that fit your style and warm your life.

The result is a series of industry firsts, accomplished through our on-going mission to provide you with the best possible wood burning technology.

First Glass Air Wash System
because a beautiful fire should be seen

First Floating Firebox Design
longer stove life with unrestricted thermal expansion

First Air Tight Ash Removal System
for quick, clean maintenance of your stove

First Extended Burn Technology
maximum efficiency for longer burns

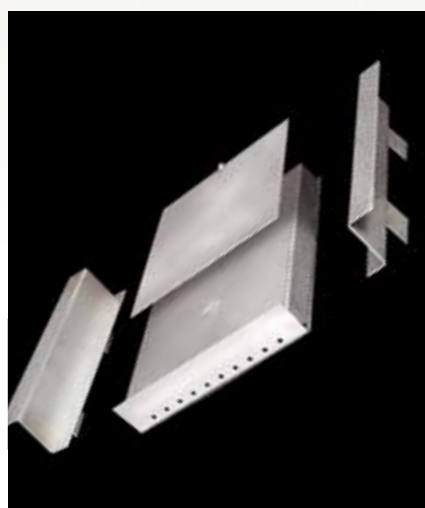

Pacific Energy's Floating Firebox eliminates metal fatigue caused by expansion and contraction during heating and cooling. Many of the firebox components are manufactured with corrosion-resistant 304 Stainless Steel. This combination of innovation and attention to detail dramatically extends the life of your appliance.

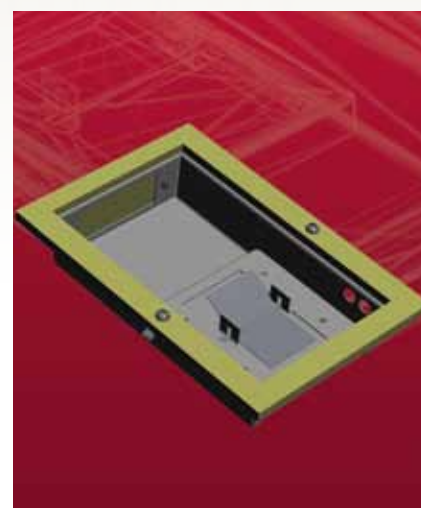

Pacific Energy's patented Extended Burn Technology is available exclusively on T6 wood stoves. EBT regulates the flow of combustion air throughout the burn cycle and increases burn time. With EBT, your T6 will burn longer between loads and deliver more efficient fuel consumption.

Patent Pending

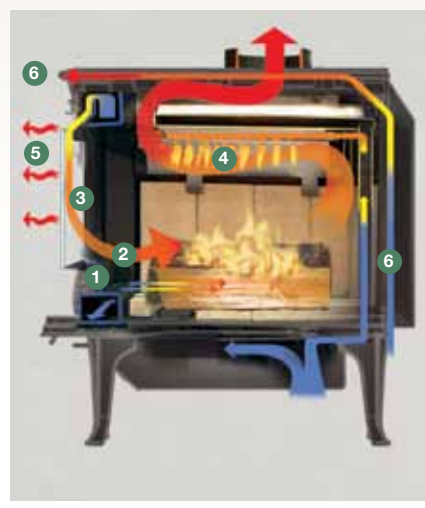

The Pacific Energy Integrated Combustion System

- 1 Boost Air
- 2 Main Combustion Air
- 3 Air-Wash System
- 4 Secondary Combustion Air
- 5 Radiant Heat
- 6 Convection Heat



Efficient Wood Heating is good for the Environment

Wood heat is a responsible choice and is a renewable and sustainable fuel source which does not contribute to global warming. When wood is burned as a substitute for fossil fuels, the result is a net reduction in CO2 emissions.

By choosing a Pacific Energy woodstove and responsible wood heating, you are making a difference. For over 30 years, a strong dedication to the environment and woodheat science has made Pacific Energy a recognized leader in hearth product innovation and clean burn

technology. Our unique firebox design and stainless steel encapsulated baffle system burn with results meeting and exceeding EPA and CSA Standards. Improving environmental performance and energy efficiency continues to be Pacific Energy's primary focus, giving you peace of mind that heating your home with a Pacific Energy Wood Stove or Insert means choosing a green home heating solution.





2011/12

CAST IRON WOOD STOVES & INSERTS

— Where Tradition, Craftsmanship and Performance meet. —



For your assurance of warmth and peace of mind, we further our commitment to quality and innovation with Pacific Energy's Limited Lifetime Warranty – we know of no better cast iron woodstove guarantee.

PACIFIC ENERGY
FIREPLACE PRODUCTS

PACIFIC ENERGY
FIREPLACE PRODUCTS LTD.

pacificenergy.net
1-888-223-0088