

TOP VIEW

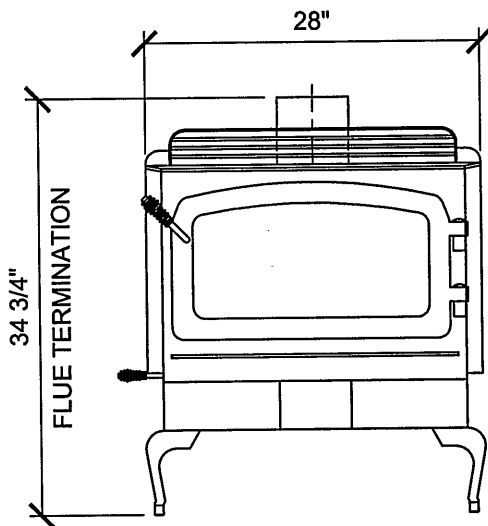

FRONT VIEW

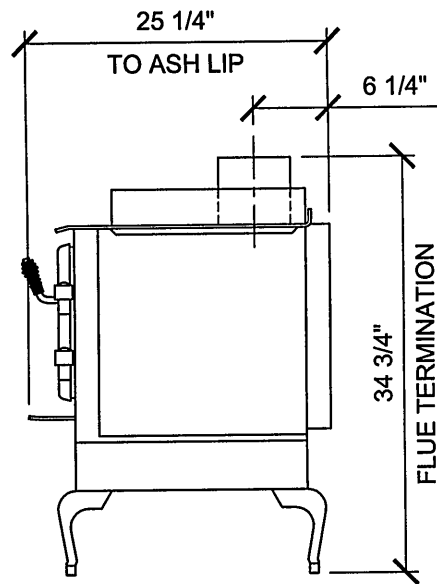

SIDE VIEW

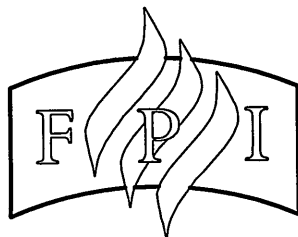

PROJECT TITLE:

FPI FIREPLACE PRODUCTS
INTERNATIONAL LTD.

SHEET TITLE:

REGENCY FREESTANDING
WOOD STOVE - F3100 WITH LEGS

DATE: FEB. 2005

DRAWN: U.D.S. Ltd.

DESIGNED: U.D.S. Ltd.

APPROVED:

DRAWING No.: 1 of 1

F3100

REV.: 0